



**DUCTILE IRON PIPES & FITTINGS**





- D** Diverse application
- U** Unique mechanical properties
- C** Can withstand high pressure & surge
- T** Tensile strength is highest among pipes
- I** Impact Resistant. No transit damage
- L** Leak-tight joint
- E** Easy to lay. Faster installation
  
- I** Inherently corrosion resistant
- R** Reliable internal & external projection
- O** Offers lower friction loss
- N** No cathodic protection required
  
- P** Pumping cost is lower
- I** Impermeable pipe body
- P** Proven track record & durability
- E** Eliminates recurring maintenance

# INTRODUCTION

Electrosteel is India's market leader in Ductile Iron Pipeline systems with one overriding aim: to be the First Choice. Electrosteel is the pioneer to set up a Ductile Iron Spun Pipe Plant in India for the first time in 1994 and since then, Water Engineers in India have shown distinct preference for Ductile Iron Pipes and Fittings due to its high reliability and durability. Electrosteel has maintained its leadership by continuous evolution of unrivalled product range, regularly updating the manufacturing processes, extensive research for product development, a vigilant quality system and user friendly services to its customers. With a global ambition Electrosteel has now spread its wings in more than 90 countries across five continents exporting Ductile Iron Pipes and Fittings as per the International Benchmark. Apart from the growing Indian demand, it caters to a large customer base spread over the Indian subcontinent, South East Asia, Middle East, Europe, USA, South America and Africa. A large marketing network spearheaded by a dedicated work force serves a diverse customer base spread around the globe.

Electrosteel employs latest state-of-the-art technology and management concepts to achieve "Quality right the first Time". Apart from having ISO:9001, ISO 45000, ISO 50000 and ISO:14001 certification, company's quality system and products are also approved by agencies like DVGW (Germany), KITEMARK (BSI, UK), and various quality approvals in Middle East. New feathers have been added by way of NSF, UL and FM approvals from USA and NF Approval from France. ECL products are also certified by Drinking water Inspectorate (DWI) and Water Regulation Advisory Scheme (WRAS) of UK.

## MANUFACTURING UNITS

- Ductile Iron Pipe Plant at Khardah, near Kolkata, in West Bengal.
- Ductile Iron pipe plant at Srikalahasthi in Tirupati district of Andhra Pradesh, India.
- Industrial unit at Haldia in West Bengal. It has a coke oven, a sponge iron plant and a 12 MW power plant.
- Both at Khardah and Haldia, it has Ductile Iron Fittings manufacturing facilities
- A Cast iron pipe plant at Elavur, near Chennai, in Tamilnadu.

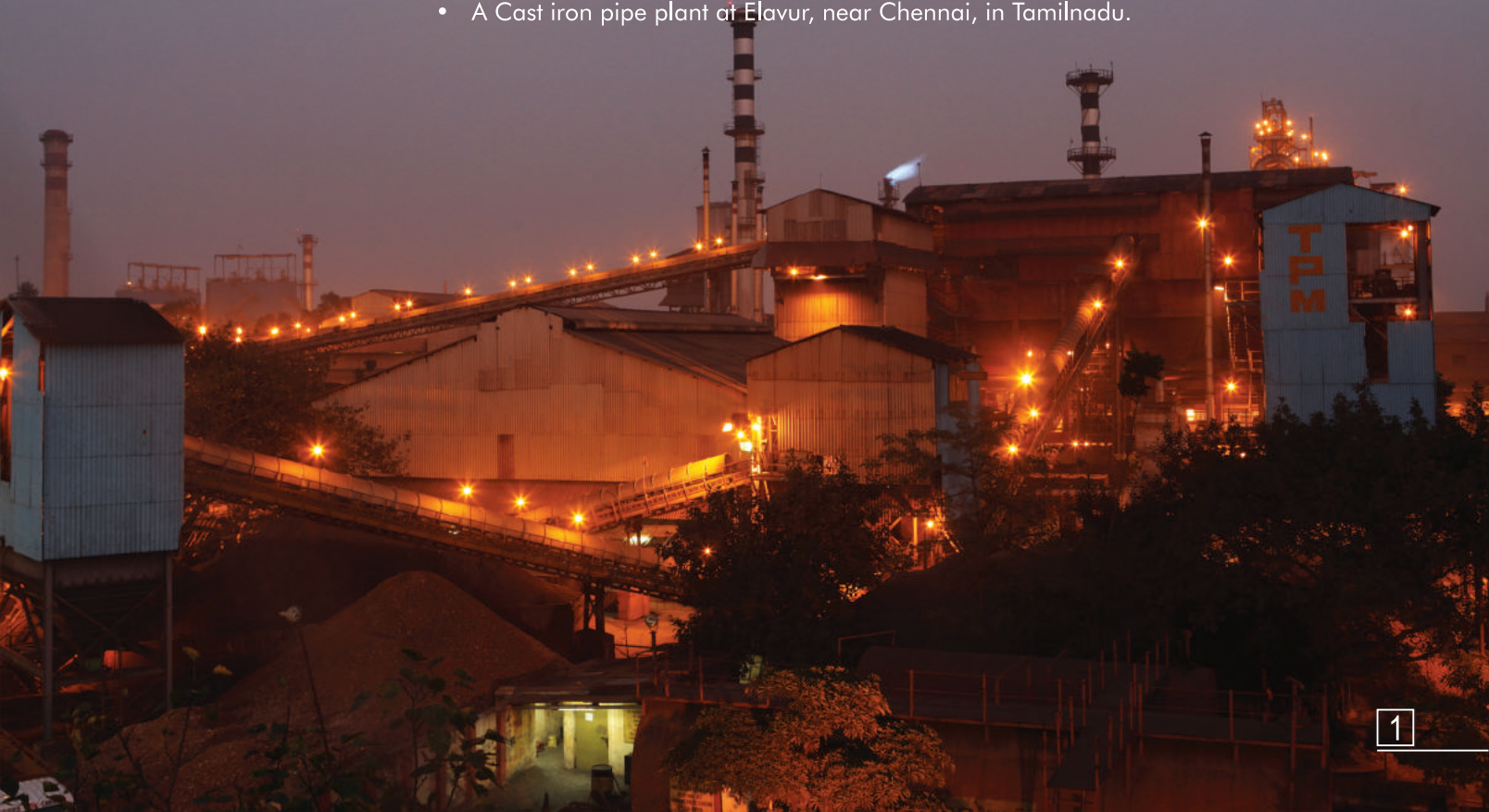



# DUCTILE IRON PIPE

## AN OVERVIEW

Ductile Iron (also known as Spheroidal graphite iron or Nodular Cast Iron) was invented in 1949. Ductile Iron retains the corrosion resistance of cast iron but has more than double the tensile strength [Cast Iron-180 MPa (min), Ductile Iron - 420 MPa (min)]. The essential differences between Ductile and Cast Iron lies in the shape of the graphite in the microstructure of the metal. In Cast Iron, the graphite is present in plate-like flakes, which makes Cast Iron brittle. But in Ductile iron, the shape of the graphite becomes a spheroidal nodule, which increases tensile strength and makes Ductile Iron sturdy and shock-proof.

Ductile Iron pipe is considered as the most preferred pipe material for water supply and pressure sewerage application all over the world. It offers higher Tensile Strength and diametral stiffness than Mild Steel and retains the inherent corrosion resistance of cast iron. Pipes made from Ductile Cast Iron, provides substantial benefits in terms of pressure bearing ability, impact resistance and capacity to sustain external static/ dynamic loading.

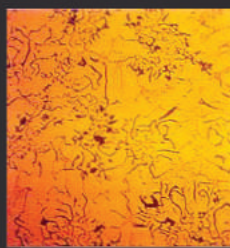

Photomicrograph showing graphite form in gray iron.

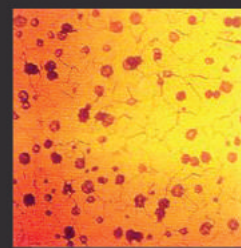

Photomicrograph showing graphite form in ductile iron.

## PROPERTIES

Properties	Ductile Iron Pipe
Tensile strength	Min. 420 MPa
Elongation (min) at break	10 %
Elastic Coefficient	$1.7 \times 10^4$ Kg/mm <sup>2</sup>
Modulus of Elasticity	$1.7 \times 10^{10}$ Kg/M <sup>2</sup>
Hardness	Max. 230 BHN
Density	7050 Kg/M <sup>3</sup>
Bending/ Beam Strength	Over 50 Kg/M <sup>3</sup>
Crush load and impact load	Can take up huge impact load (Charpy over 0.713).
Bursting Strength (min)	Factor of Safety against bursting is 8 to 10.



# PIPE MANUFACTURING PROCESS

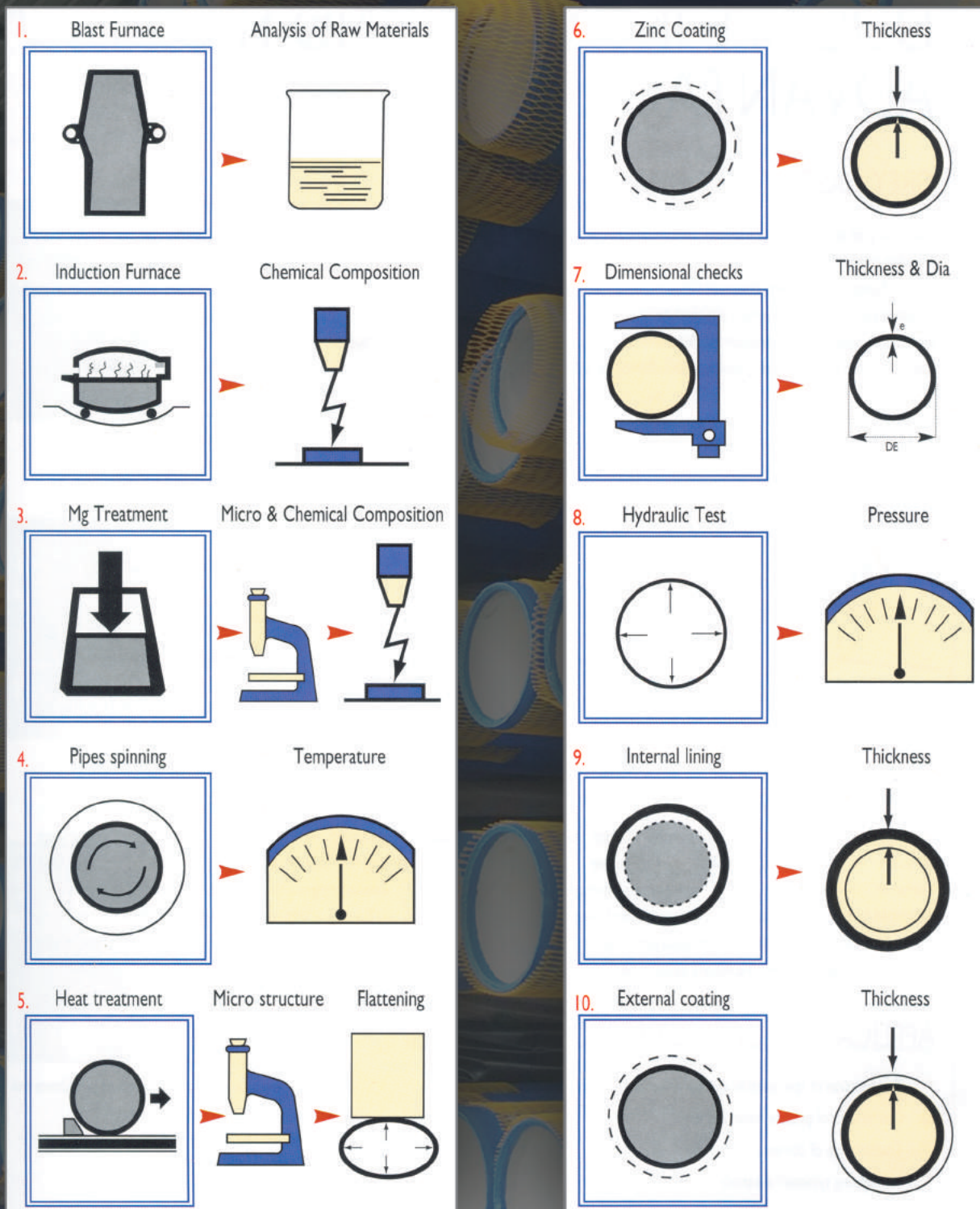



## APPLICATION OF

# DUCTILE IRON PIPE



- Raw and clear water transmission (pumping and gravity main)
- Distribution network of potable water
- Irrigation (lift & gravity irrigation)



- Water supply for industrial /process plant application
- Ash-Slurry Handling & Disposal system
- Fire-fighting systems- on-shore and off-shore
- Desalination Plants



- Sewerage and waste water force main
- Gravity sewerage collection and disposal system
- Storm water drainage piping
- Effluent disposal system for domestic and industrial application
- Recycling system



- Piping work inside water and sewage treatment plants
- Vertical connection to utilities and reservoirs



- Piling for ground stabilization
- Protective piping under major carriage-ways





## PRODUCT RANGE

Electrosteel produces Ductile Iron Spun Pipes and Fittings from DN 80 – DN 1200 mm:

- As per IS : 8329 / IS : 9523
- As per ISO : 2531 (for water)
- As per BS EN : 545 (for water)
- As per EN : 598 / ISO : 7186 (for sewerage)

Normally pipes are manufactured with inside cement mortar lining and external Zinc coating with a bitumen finishing layer. Various other linings and coatings are possible as per customer's request.

### Range of Pipes

- Ductile Iron Socket and Spigot pipes with push on joints.
- Ductile Iron plain ended barrel pipes.
- Ductile Iron Socket and Spigot Restrained joint pipes with push-on Rubber Gasket Joint.
- Ductile Iron Flanged pipes of standard and customized length. Flanged Pipes of the following types are available;
  - Flanges as cast (short lengths upto 1m).
  - Welded on Flanged pipes.
  - Screwed on Flanged pipes.

### Range of Fittings

- All Socketed Ductile Iron Fittings with Push-on Joints.
- All Flanged Ductile Iron Fittings.
- Ductile Iron Fittings with push-on type restrained joint.
- Ductile Iron Mechanical Joint Fittings with Rubber Gasket & follower gland.
- Fabricated and custom made Ductile Iron Fittings.





## JOINTING

# SYSTEMS

Electrosteel D.I. Pipes and Fittings are available with following types of jointing systems:

- Socket & Spigot Flexible Push-on Joints
- Restrained Joints Push-on Type
- Mechanical Flexible Joints (only fittings)
- Flanged Joint

## Socket & Spigot Flexible Push-on Joints

Socket and Spigot Flexible Joints are assembled with synthetic (EPDM/SBR) rubber gaskets of special shape. The gasket has a hard 'Heel' and soft 'Bulb'. In Push-on joint the soft bulb of the rubber gasket is compressed when the spigot is inserted into the socket. The 'Heel' locks the position of the gasket and does not allow the gasket to get displaced when the spigot is pushed in. The joint becomes tighter with the increase in internal pressure of water. The rubber is confined in a place and cannot blow out.

### Permissible Deflection at Socket and Spigot Joints

Where it is necessary to deflect the pipeline from a straight line, either in the vertical or horizontal plane, to avoid obstructions etc., deflection at joint should not exceed the following:

DN (mm)	Max Deviation Angle
80 – 150	5°
200 – 300	4°
350 – 600	3°
700 -1200	2°

### Electrosteel Ductile Iron Pipe joints are type tested

Electrosteel's design of the socket and the rubber gasket ensures guaranteed leak-tight joint through Type Test as per BSEN:545 and ISO:2531. Type Test is testing the pipe and pipe joint at extreme working conditions (the product and use) to ensure satisfactory performance for a long time.

**The recommended Type Tests as per BS EN:545/598, ISO 2531 are :**

- 1) Compressive Strength of the Cement Mortar Lining
- 2) Longitudinal Bending of Pipes
- 3) Diametral Stiffness of Pipes
- 4) Leak tightness of components for Gravity Pipelines
- 5) Leak tightness of Flexible Joints to positive internal pressure
- 6) Leak tightness of Flexible Joints to negative internal pressure
- 7) Leak tightness of Flexible Push-in Joints to positive External pressure
- 8) Leak tightness of Flexible Joints to dynamic internal pressure
- 9) Chemical resistance to effluents
- 10) Abrasion Resistance

The British Standard Institute (BSI) has supervised the type tests and accordingly the 'KITEMARK' Licenses have been issued.



## Procedure



**Step 1 :** Clean the socket grooves and outside spigot end.



**Step 2 :** Hold the gasket as shown and place inside the socket



**Step 3 :** Apply lubricant on the gasket. Do not use petroleum based lubricant.



**Step 4 :** Apply lubricant on the spigot also. Please check that the spigot end is properly chamfered.



**Step 5 :** Properly align both the pipes.



**Step 6 :** Gently push the spigot into the socket with suitable mechanical means.

## Rubber Gasket

The absence of sunlight and oxygen, presence of moisture/water, relatively lower and uniform surrounding temperature in buried conditions help in preservation of rubber gaskets. Thus this type of joint is expected to last for more than 100 years.

- Good quality Synthetic rubber gaskets made either of SBR (Styrene Butadyne Rubber) or EPDM (Ethylene Propylene Dimethyle Monomer) conforming to IS:5382 are used with Ductile Iron push-on joint pipes.
- Gasket should be stored in a cool & dry place. Direct exposure to sunlight should be avoided.
- It is advised that the users should obtain gaskets through Electrosteel only.

## Joining Tips

- The sockets should face uphill while pipeline is laid on a slope.
- The direction of flow has nothing to do with direction of the socket.
- Never use petroleum based lubricant during jointing. It damages the gasket. Liquid soap solution or organic grease may be used.
- All Fittings should be suitably anchored against displacement as recommended in the laying specification.
- Spigots should be inserted into the socket upto the white insertion mark to ensure proper jointing.
- The joint deflection should not be more than the recommended deflection.





## Restrained Joint Push-on Type for Buried Pipe

Restrained Joints are special jointing system, which can take care of axial movement in case of thrust. Hydraulic thrust forces occur in pressurized mains, when there is any change in direction (bends, tees) or any change of diameter (tapers, valves) or any pipeline end (blank flanges or caps). These special joints are necessary on fittings and a few pipes adjacent to the fittings. Restrained Joints eliminate use of concrete anchor blocks, which are costly and delay the progress of laying operation

### Boltless Restrained Joint (Electrolock)

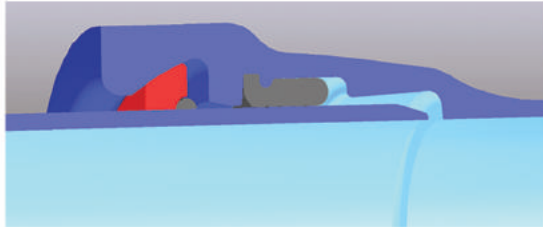

1. Need long socket pipes with two chambers: one for normal sealing and the other for restraining axial movement.
2. The water sealing is done by Push-on gasket and restraining is done by weld Bead and Locking Bar.
3. After assembly, the locking bars are to be inserted in the locking chamber. The weld bead on the spigot gets locked with the locking bar against separation force.

DN (mm)	Angular Deflection (Degree)	AOP (Bar)*
80	5	64
100	5	64
125	5	64
150	5	55
200	4	44
250	4	39
300	4	37
350	3	32
400	3	30
450	3	30
500	3	30
600	3	30
700	3	30
800	3	25
900	3	25
1000	3	25

Note:- Applicable for K9 or equivalent pipes

4. As no thrust block is needed it takes lesser time to lay pipes
5. Very useful where there is no place for thrust blocks
6. Can be used for trenchless applications
7. Easy to assemble and disassemble.

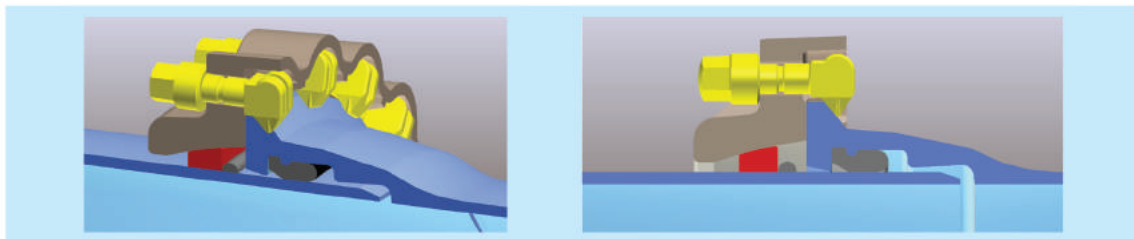

### Bolted Restrained Joint

1. It needs specially manufactured pipes, with hood on the socket and Weld Bead on spigot.
2. Need special accessories like Gland, Split Retainer Ring and Nuts/ Hook Bolts.
3. The water sealing and restraining are in two different systems.
4. Normal gasket to be used for sealing.
5. The Hook Bolts with the support from socket hood hold the gland and the socket together. The welding bead on the other pipe's spigot cannot pass through Retainer Ring housed in the gland, ensures restraining axial movement between the two pipes.
6. Easy to assemble and disassemble when required.

DN (mm)	Angular Deflection (Degree)	AOP (Bar)*
80	5	64
100	5	64
125	5	64
150	5	55
200	4	44
250	4	39
300	4	37
350	3	32
400	3	30
450	3	30
500	3	30
600	3	27
700	2	25
800	2	16
900	2	16
1000	2	16

Note:- Applicable for K9 or equivalent pipes

\* Note : AOP - Allowable Operating Pressure (Excluding Surge)



## Flanged Joints

Over ground and specialized applications require restrained joints where Flanged pipes are used. Flanged Pipes have the following advantages:

- 1) Acts as self-restrained Joint reducing the requirement of thrust blocks.
- 2) Ideal for over-ground and Exposed Installations.
- 3) Flanged Pipes are ideal for Vertical pipelines.
- 4) Used for Temporary Installations (over pillars) where pipelines need to be disengaged or displaced.
- 5) Widely used for interconnection in Pump House and Treatment Plant.

Type of Pipe	Dia, Range and Lengths	PN Ratings
<b>Welded Flanged Pipes</b>		
Flanges are welded on either side of a Class K9 Barrel or equivalent C Class	From 80 to 1200 mm diameter and length up to 5.4 mtr.	PN 10, PN 16 PN 25, PN 40
<b>Screwed Flanged Pipes</b>		
Flanges are screwed-fit on either side of a Class K9 Barrel or equivalent C Class	From 80 to 400 mm diameter and length up to 5.4 mtr.	PN 10, PN 16
<b>"As Cast" Flanged Pipes</b>		
Flanged Pipes are cast as a single unit using advanced Lost Foam method.	From 80 to 1200 mm diameter.	PN 10, PN 16 PN 25, PN 40

Electrosteel manufactures Flanged Pipes using all the three methods, that is, Welded Flanged Pipes, Screwed Flanged Pipes and integrally Cast Flanged Pipes (short lengths). Other types of coating and lining to the Flanged Pipes are also available. All flanged pipes are normally lined with Cement Mortar and has outside Zinc and Bitumen Coating.

### Jointing Procedure

- ✓ Properly align the pipes
- ✓ Clean flange faces and remove rust and dirt
- ✓ Position the gasket. Use 3 mm. thick moulded rubber gaskets with quality conforming to IS 5382.
- ✓ Lubricate bolt threads, all mating surface and flanges
- ✓ Use automotive grade oil grease
- ✓ Insert the nut-bolts one by one. Tighten diametrically opposite bolts to the recommended torque
- ✓ If necessary, re-tighten bolts before pressure testing

### Remember....

- Buried installation of flanged pipe is not recommended.
- Flanged joint being a rigid joint, perfect alignment of the flange faces during jointing and bolt tightening is absolutely vital.
- Use of duckfoot bend at bottom of vertical flanged pipe line is necessary.
- For high pressure application, flanged pipeline needs thrust block/ support at bends / tees.





# PIPE

## DIMENSION

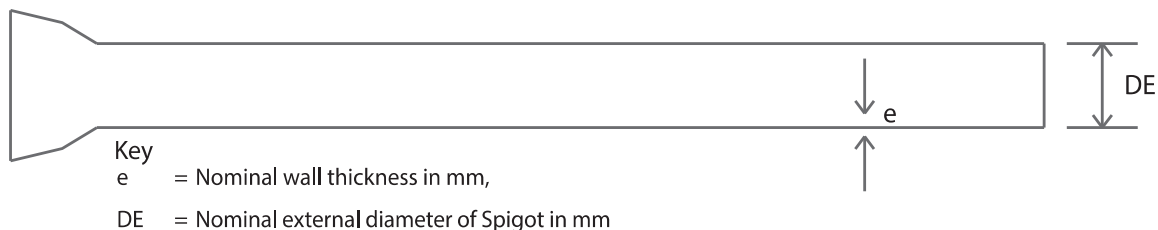

### Basic Dimensions of Pipes Class K7 & K9

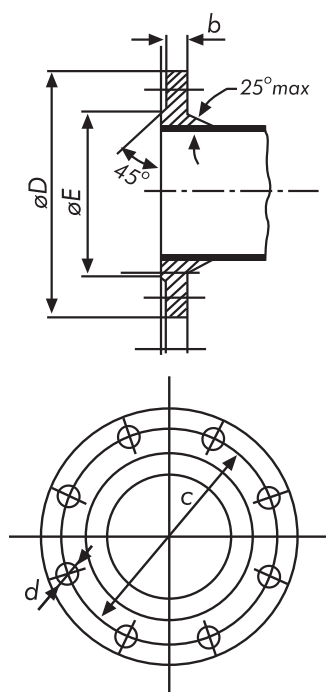

Nominal Dia. DN (mm)	External Dia. DE (mm)	Tol. on DE (mm)	Nominal Thickness K7 (mm)	Nominal Thickness K9 (mm)	Allowable Deflection (Degree)
80	98	+1/-2.7	5.0	6.0	5
100	118	+1/-2.8	5.0	6.0	5
125	144	+1/-2.8	5.0	6.0	5
150	170	+1/-2.9	5.0	6.0	5
200	222	+1/-3.0	5.0	6.3	4
250	274	+1/-3.1	5.3	6.8	4
300	326	+1/-3.3	5.6	7.2	4
350	378	+1/-3.4	6.0	7.7	3
400	429	+1/-3.5	6.3	8.1	3
450	480	+1/-3.6	6.6	8.6	3
500	532	+1/-3.8	7.0	9.0	3
600	635	+1/-4.0	7.7	9.9	3
700	738	+1/-4.3	9.0	10.8	2
750	790	+1/-4.4	9.7	11.3	2
800	842	+1/-4.5	10.4	11.7	2
900	945	+1/-4.8	11.2	12.6	2
1000	1048	+1/-5.0	12.0	13.5	2
1100	1152	+1/-6.0	14.4	14.4	2
1200	1255	+1/-6.2	15.3	15.3	2

### Dimensions of Flange

DN Nom	PN10						PN16					
	D	E	C	b	n	Metric	D	E	C	b	n	Metric
	Outside Dia	Dia of raised Face	Pitch Circle Dia	Flange width	No. of Bolts	Bolt size/ Total length/ Thread length	Outside Dia	Dia of raised Face	Pitch Circle Dia	Flange width	No. of Bolts	Bolt size/ Total length/ Thread length
80	200	132	160	16	4	M16x70/38	200	132	160	16	8	M16x70/38
100	220	156	180	16	8	M16x70/38	220	156	180	16	8	M16x70/38
125	250	184	210	16	8	M16x70/38	250	184	210	16	8	M16x70/38
150	285	211	240	16	8	M20x80/46	285	211	240	16	8	M20x80/46
200	340	266	295	17	8	M20x80/46	340	266	295	17	12	M20x80/46
250	395	319	350	19	12	M20x80/46	400	319	355	19	12	M24x90/54
300	445	370	400	20.5	12	M20x90/46	455	370	410	20.5	12	M24x90/54
350	505	429	460	20.5	16	M20x90/46	520	429	470	22.5	16	M24x90/54
400	565	480	515	20.5	16	M24x90/54	580	480	525	24	16	M27x100/60
450	615	530	565	21	20	M24x90/54	640	548	585	26	20	M27x100/60
500	670	582	620	22.5	20	M24x100/54	715	609	650	27.5	20	M30x110/66
600	780	682	725	25	20	M27x100/60	840	720	770	31	20	M33x120/78
700	895	794	840	27.5	24	M27x110/60	910	794	840	34.5	24	M33x130/78
750	960	857	900	29	24	M27x110/60	970	857	900	36	24	M33x130/78
800	1015	901	950	30	24	M30x120/66	1025	901	950	38	24	M36x140/84
900	1115	1001	1050	32.5	28	M30x120/66	1125	1001	1050	41	28	M36x150/84
1000	1230	1112	1160	35	28	M33x130/78	1255	1112	1170	45	28	M39x160/103
1100	1340	1231	1270	38	30	M33x130/82	1355	1218	1270	48.5	32	M39x160/110
1200	1455	1328	1380	40	31.5	M36x140/84	1485	1328	1390	52	32	M45x170/115



# DUCTILE IRON

## FITTINGS



### Manufacturing Procedure

The 'Lost foam' process used for manufacturing of DI fittings, is a much advanced technique and it scores over other conventional process.

#### Lost Foam Casting Technique

- ✓ First an exact replica of the fitting is made with "Styro-foam" popularly known as Thermo-cole.
- ✓ This replica, moulded in special machines, acts as a pattern for the casting. The patterns are then kept in mechanized moulding box and then packed with sand.
- ✓ When hot metal is poured, the Styrofoam pattern vapourises (a vacuum pump removes the gases) and the metal takes the shape of the fitting by filling up the cavity.
- ✓ After cooling, castings are taken out, shot blasted, fettled and cleaned.
- ✓ After thorough inspection, the castings (Fittings) are subjected to hydrostatic testing.
- ✓ Tested fittings are then cement mortar lined and Zinc coated and a bituminous finishing coat is applied from outside. Fittings with Fusion Bonded epoxy coating and lining are also available.

#### Advantages of Lost Foam Technique

- Casting process is much faster, leading to quicker delivery.
- No need of core setting. So no question of core displacement resulting in uneven thickness.
- Much lower chances of having pinhole, slag inclusion or blowhole.
- Maintains high dimensional tolerance, which is so vital for proper fitment and leak tightness. The castings have excellent finish.
- In flanged fitting no drilling hole is necessary as all the holes are cored.

### Hydrostatic Testing

D.I. fittings are tested at works at the following test pressure as specified in IS : 9523

Diameter (mm)	Works Test Pressure (Kg/cm <sup>2</sup> )
80-300	25
350-600	16
700-800	10
900-1200	10

It may appear that test pressures of Fittings are low, compared to the allowable working pressures in pipes. But fittings with K-12 thickness of Ductile Iron have higher factor of safety and do not burst at allowable working pressure.

Electrosteel has set up a new DI fittings plant at Haldia, employing high pressure casting system. This results in accurate dimension and faster production. At Haldia, DI fittings upto 1200 mm dia are produced.





## DUCTILE IRON SPECIAL FITTINGS

Apart from push-on joint and mechanical joint fittings we also manufacture some special fittings, which are extremely useful for practical applications. These have same wall thickness, material and quality tests of standard fittings. Few of these are mentioned below:

- ✓ 4 way Crosses
- ✓ Double Socket Branch Flange level Invert Tee (Scour Tee)
- ✓ Caps/Plugs/Puddle Flange
- ✓ Special variation of conventional Fittings such as:
  - Fittings with one side Flange & one side plain-ended/ socketed of a particular length.
  - Tees and Reducers with other non-standard DN x dn combinations.
  - Due to immense flexibility of our manufacturing process by Lost Foam method, virtually any combination of socket/flange plain-end is possible.

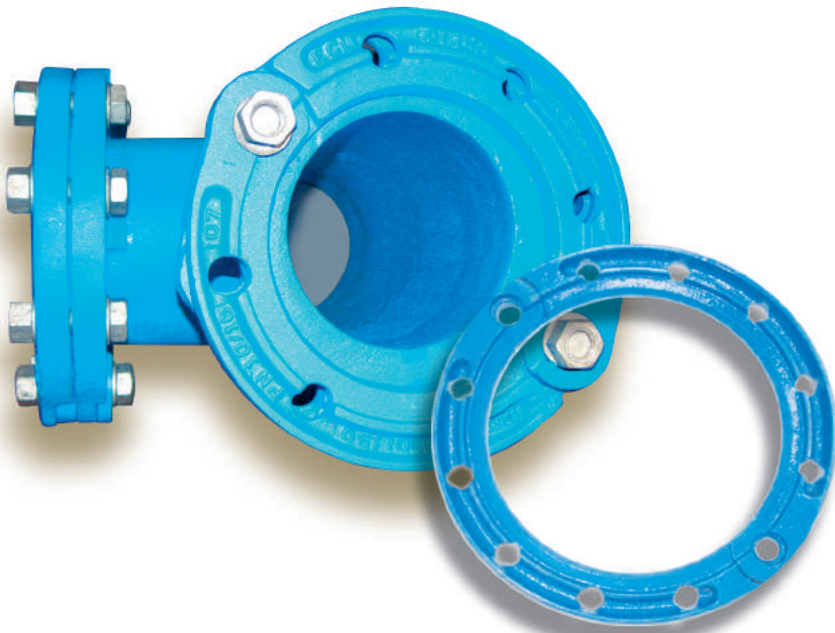

## Electrosteel Brand name

Electrosteel produces Ductile Iron Pipes in the main two plants i.e. Khardah in West Bengal and at Srikalahasthi in Andhra Pradesh. Pipes produced at Khardah works are branded as 'ELECTROSTEEL' pipes and pipes produced at Srikalahasthi works are branded as 'SRIPIPES'.

Brand name of pipes produced at Khardah works



Brand name of pipes produced at Srikalahasthi works





## INTERNAL

# PROTECTION

## Cement Mortar Lining

Normally all pipes are supplied with centrifugally applied cement mortar lining. Fittings are supplied with manually applied cement mortar lining. The mortar of the lining is composed of cement, sand and water.

### Recommendations

Type of cement can be chosen as per the type of water/ effluent.

Water Characteristics	Portland Cement	Sulfate Resisting Cements (incl. Blast furnace slag cement)	High Alumina Cement
Min value of pH	6	5.5	4
Max content (mg/L) of			
- CO <sub>2</sub>	7	15	no limit
- Sulphates (SO <sub>4</sub> )	400	3000	no limit
- Magnesium (Mg++)	100	500	no limit
- Ammonium (NH <sub>4</sub> ++)	30	30	no limit

### Advantages

- ✓ Centrifugally applied CML provides higher Hazen William's C value of 140 compared to 100 for bare metallic pipes.
- ✓ Reduces frictional head loss and pumping cost.
- ✓ CML passivates the pipe wall against corrosion by the alkaline reaction of cement.
- ✓ CML prevents pitting and tuberculation of pipes and stops the production of red water.
- ✓ CML helps to maintain same flow area and co-efficient of friction over a long period of time.



### Thickness of the Lining

The normal thickness of the lining and the minimum permissible values are given in the table below

DN (mm)	Thickness (mm)	
	Normal Value	Tolerance
100 - 300	3.0	-1.5
350 - 600	5.0	-2.0
700 - 1200	6.0	-2.5

On contraction of the lining, the formation of minor cracks cannot be avoided. These cracks together with other isolated cracks, which may develop during transportation are acceptable in the standard specifications upto a width of 0.8 mm. These cracks heal up due to formation of new crystals when the pipe surface comes in contact with water.

### Seal Coat on Cement Mortar Lining

When specified or prescribed by the customer the cement mortar lining is given a seal coat of asphaltic material. On specific requirement of customer we provide Epoxy Seal Coat over Cement Lining. The purpose of the seal coat is to control leaching of cement into Water.

## PU Lining

For Conveying aggressive fluid, inside Polyurethane lining in pipe following EN 15655 has been introduced. This lining offers excellent chemical and abrasion resistance and offers high lining durability.

## EXTERNAL

# PROTECTION

### For DI Pipes

The International Standard IS: 8329 / ISO 8179 establishes the main features of Zinc coating as well as suitable methods for checking them.

- Standard 130 gm/m<sup>2</sup> and Bituminous or Epoxy finishing layer of 70 microns
- As per customer requirement 200 gm/m<sup>2</sup> of Zinc coating and Bitumen or Epoxy finishing layer of 70 micron
- As per customer requirement 400 gm/m<sup>2</sup> Zinc Aluminium Alloy (for very corrosive soil) coating with a finishing layer of Bitumen or Epoxy

In case of fittings normally Zinc rich paint coating is applied instead of metallic Zinc coating

### Zinc/Zinc Aluminium Alloy Coating

The Zinc / Zinc Aluminium alloy coating consists of a metallic Zinc/ Zinc Aluminium alloy layer applied by metallization on the pipe surface. This layer is obtained by the juxtaposition of small droplets of molten Zinc/ Zinc Aluminium alloy on the pipe surface, which is a patented process.

The metallic Zinc or Zinc Aluminium Alloy covered by a finishing layer of a bituminous product or synthetic resin compatible with Zinc. Both layers are applied at the works.

An improved chemical and mechanical stability of the coating is provided by the Zinc Aluminium alloy coating.

### Epoxy Coating

Compared to normal bitumen coated pipes it offers :

- More resistance to external galvanic/ soil corrosion in aggressive soil.
- More resistance to external chemical (acid, alkali, organic) attack
- Better adherence to metal surface, hence more durable coating
- Higher scratch resistance and does not peel off in impact
- Good resistance to coating damage during transportation/ handling/laying
- Comes in attractive blue (for water) or red (for sewerage) colour.
- Hence offers much better look and aesthetics

### PU Coating

Electrosteel DI pipes are now available with Polyurethane external coating applied as per EN 15189. It offers a holiday free coating systems with excellent impact, chemical corrosion and abrasion resistance.





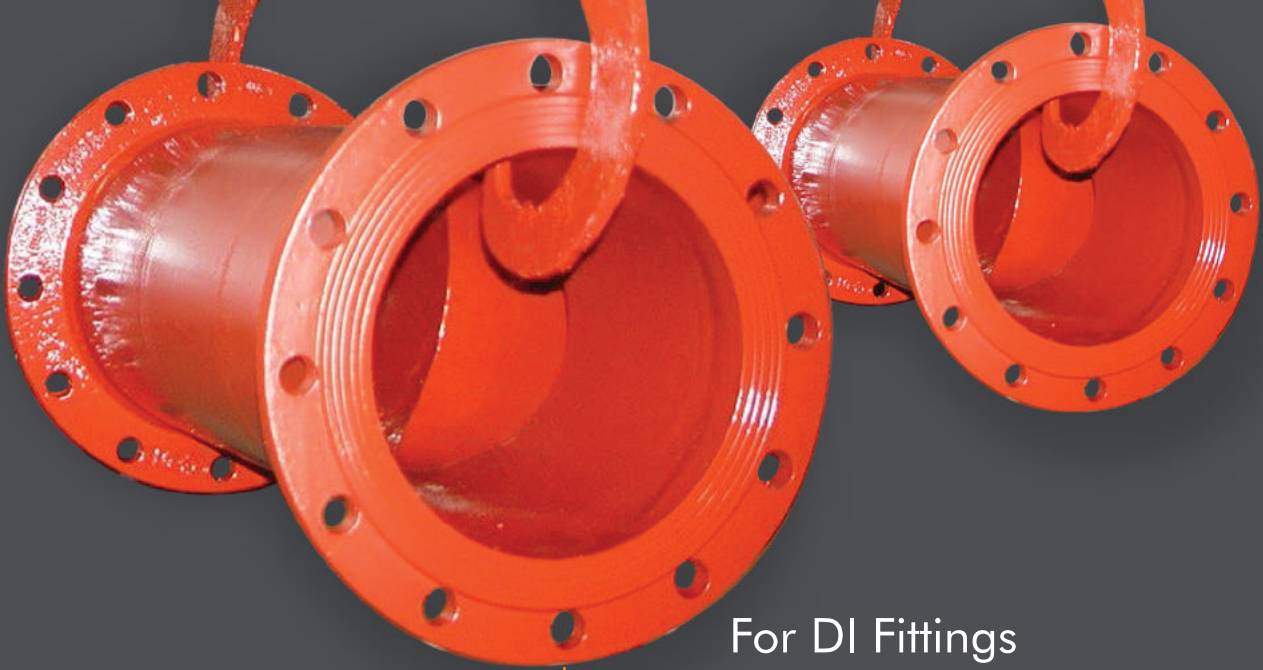

## For DI Fittings

### Polyethylene Sleeving

Loose polyethylene encasement is found to be very effective for protection of Ductile Iron Pipes and Fittings in corrosive environments and widely practiced in USA, Europe and Australia, instead of Zinc coating. Investigation of many field installations, where loose polyethylene encasement has been used as protection for Cast Iron and Ductile Iron pipelines indicates that polyethylene encasement provides, for even highly corrosive test sites, a high degree of protection. The dielectric capability of polyethylene provides shielding for Ductile Iron Pipes and Fittings from stray direct current encountered in the field. When Ductile Iron Pipes are laid with P.E. sleeving, the fittings are also covered with P.E. Sleeving.

Normally Fittings are coated with zinc rich paint covered with a finishing layer of bitumen or epoxy.

### Fusion Bonded Epoxy Coating (FBE)

This is special coating with added advantage. A state-of-the-art automated facility has been created to coat DI Fittings with powdered epoxy by fusion bonding process. This inert coating in attractive colour is suited for aggressive soil condition.

### Advantages

1. Gives high gloss and smooth coatings with excellent adhesion.
2. Difficult shapes can be coated evenly.
3. Provides enhanced corrosion resistant properties.
4. A choice of Blue or Red colours for water or sewage applications is available.
5. Film thickness between 200 – 250 micron, can be specified as per the requirement.
6. High film thickness (>250 micron) can also be applied as per customer requirement.





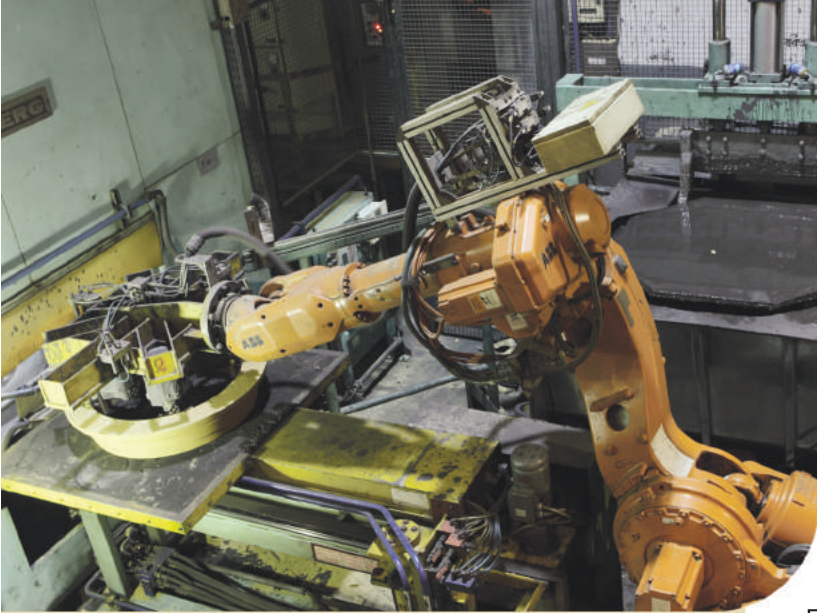

## QUALITY

# CERTIFICATION

## QUALITY

# POLICY

- Electrosteel is committed to providing goods and services which meet customers' expectations and needs.
- The aim is to achieve "Quality right at the first time".
- Electrosteel is committed to complying with the requirements and to continually improve the effectiveness of quality management system through teamwork training and motivation.
- Electrosteel shall formulate Quality objectives for all functions and involve employees in fulfilment of the same.
- The quality policy and the quality objectives will be reviewed for continuing suitability.
- This policy will be communicated and understood within the organization through training and interaction

Electrosteel has the 'ISI' licenses for Ductile Iron Pipe and Fittings which are now ISI mandatory under Quality order of 2009. Quality consciousness supported by stringent control is a hallmark of Electrosteel's manufacturing process. The quality system is assessed and approved by agencies of International reputation and Quality approvals have been received from various National and International Bodies.





# ELECTROSTEEL - TOWARDS A GREENER TOMORROW

Electrosteel is committed to reducing its carbon footprint through responsible use of natural resources and continuous process improvement. Some basic initiatives are as follows:

**Environmental Management System** - Electrosteel effectively maintains the Environmental Management System Standard ISO: 14001 since 2004. Electrosteel is one of the Ductile Iron Pipe plant in the world to get ISO 14001 certification.

**Energy Management System** - The organization has implemented an effective Energy Management System having UKAS accredited ISO 50001 certification.

Mineral recycling in Sinter Plant - Iron ore fines, coke breeze, limestone and dolomite along with recycled metallurgical wastes, are converted into agglomerated mass at the Sinter Plant, which is then charged in the Blast Furnace.

**Sponge iron plant** - Electrosteel has an integrated sponge iron plant at Haldia. Sponge iron is high in iron content and is melt directly to partially replace blast furnace pig iron. It is an effective measure to reduce the use of virgin raw material. It also reduces fuel consumption & thus carbon emission per Metric Ton of DI pipe.

**Recycling of process rejection** - Process rejection of pipes & Fittings are crushed and recycled.

**Reuse of waste Gas / waste heat** - Low calorific value waste gas like Blast furnace gas is used for various process heating and power generation. Power generation also takes place by waste heat recovery from Coke Oven & DRI Plant waste gases. Waste heat recovery is also done from flue gases at various places like Hot Blast Stoves, Sinter Plant & Heat treatment furnaces.

**Reuse of wastewater** - 94% of the waste water at the Company's plant is recycled and reused. Srikalahasthi plant of Electrosteel brings waste water from Tirupati municipality through a 21 Km pipeline, treats the water and uses it for process requirement.

## SA 8000 Certification

We have the coveted SA 8000 certification for social accountability, which ensures the following:

- Child labour - No engagement of child labour.
- Forced labour - No engagement in forced labour. No lodging of identity papers upon employment.
- Health and Safety - Ensuring Safe and healthy working environment.
- Freedom of association and the right to collective bargaining and right to form and join 'trade unions.



- Discrimination - No discrimination in hiring, compensation, promotion etc. No sexual harassment.
- Disciplinary practices - No corporal punishment, mental or physical coercion and verbal abuse.
- Working hour - Max. 48 hours per week with 1 day- off every 7 days.
- Compensation - Wages shall be at least at the legal minimum requirement or at industry standard.

## CORPORATE SOCIAL RESPONSIBILITY

The Company regards social, economic and environmental responsibilities as integral parts of the business. As part of its policy for corporate social responsibility, the Company undertakes a range of activities to improve living conditions of people in the neighbourhood of all its plants. Few examples are:

- a) Development, repair, renovation and extension of classrooms of local Institutes.
- b) Rewarding good & bright students.
- c) Financial assistance to local organizations to pursue their sports activities.
- d) Health care of local inhabitants through charitable dispensary and donation for treatment.
- e) Organize sports activities involving local schools and clubs at District level with an aim to promote sports activities in the District.
- f) Giving opportunity to local un-employed youth to develop entrepreneurship by allowing local supply, through small contracts.
- g) Organizing Cultural Programmes involving local residents.



# ESTABLISHMENTS

## Head Office

### **Electrosteel Castings Limited**

G K Tower, 19, Camac Street, Kolkata - 700017, India,  
Ph : +91 33 2283 9990/ 7103 4400

---

## Production Units

### **KHARDAH**

30, B. T. Road, Khardah, P.O. - Sukchar, Dist.- 24 Parganas (N), West Bengal, India. Pin - 700115  
Ph : +91 33 7101 4300 / 4450

### **BANSBERIA**

Vill - Chak Bansberia, Saptagram Panchayat,  
P.O. - Adconagar, Dist. - Hooghly,  
West Bengal, India. Pin - 712121  
Ph : +91 6292219270

### **HALDIA**

Vill - Kasberia, P.O. - Shibramnagar, Haldia, Dist. - Purba Medinipur,  
West Bengal, India. Pin - 721635  
Ph : +91 9083280640 / 9434095385

### **ELAVUR**

12/72 GNT Road, P.O.- Elavur, Taluk - Gummidipondi,  
Dist. - Tiruvallur, Tamil Nadu, India. Pin - 601201  
Ph : +91 44 - 67911800

### **SRICALAHASTHI**

Vill - Rachagunneri, Mandal-Srikalahasthi  
District - Tirupati, Andhra Pradesh, India. Pin - 517641  
Ph : +91 8578 286650 - 55

[www.electrosteel.com](http://www.electrosteel.com)